



# 556237 STACKABLE FEATHERBOARD PKG

## INTRODUCTION

This set of Stacking Featherboards will aid you with tall woodworking operations on the TableSaw and Bandsaw. Along with the quad-stack of featherboards for work up to 6" tall and more, this pack of featherboards and hardware can be made into two double-stack featherboards or a triple-stack with a single featherboard for the in-between jobs.

## TOOLS REQUIRED

- 3/8" Open End Wrench
- 5/16" Open End Wrench
- Measuring Scale

## SAFETY

**WARNING**

**READ, UNDERSTAND AND FOLLOW ALL THE INFORMATION IN THIS OWNER'S MANUAL.**

- ◆ **Read, understand and follow the Mark V/7 Owner's Manual, Bandsaw Owner's Manual and the manual for every power tool you use.**
- ◆ **Plan every operation before you begin. If you are in doubt about how to perform an operation safely, do not attempt it. Consult your Owners Manuals and Power Tool Woodworking for Everyone textbook for proper, safe technique. If you are still unsure about performing the operation, contact a Shopsmith Customer Service associate.**

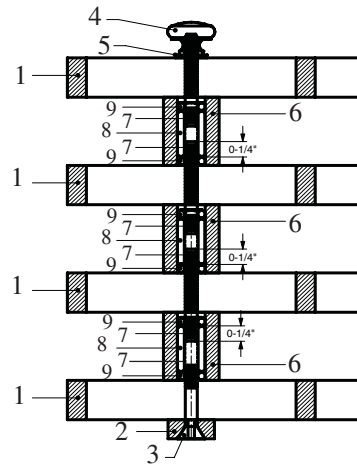

## PARTS LIST

Ref	Part Number	Description	Qty
1	518216	Featherboard .....	4
2	513707	Expansion Bar .....	2
3	513705	Pin .....	4
4	513713	Knob .....	4
5	513864	Washer .....	4
6	522880	1" Tall Plastic Spacer .....	6
7	522881	Stud #10-24 x 1-1/2" .....	6
8	5228829	Coupling Nut #10-24x5/8" .....	6
9	274737	Hex Nut .....	12

- ◆ **Always wear eye protection when you use power equipment. Use goggles, safety glasses or a face shield to protect your eyes.**
- ◆ **Goggles completely surround and protect your eyes. Many goggles will also fit over regular glasses. Be sure your goggles fit closely, but comfortably.**
- ◆ **Safety glasses don't fog as easily as goggles and can be worn all the time. Regular eye-glasses normally have only impact resistant lenses. They are not safety glasses.**
- ◆ **A face shield protects your entire face. And you can flip it up out of the way when you don't need it. A face shield can be used with regular glasses.**

- ◆ Prolonged exposure to high noise levels from high speed power equipment can damage your hearing.
- ◆ Hearing protectors screen out noise that can damage your ears. Wear hearing protection when you are exposed to high intensity power equipment noise.

## FEATHERBOARD WARNING

- ◆ Never position the Featherboard to push the workpiece directly against a blade, cutter, or disc. Pinching the workpiece against a blade, cutter, or disc will cause kickback.
- ◆ Always use a vertical fence extension securely fastened to the fence used to guide the workpiece if the combined Featherboards and workpiece are taller than the rip fence. See the Table Saw and Bandsaw chapters in the Power Tool Woodworking for Everyone textbook.
  - ◆ The fence must be as tall or taller than the total height of the Featherboard stack.
- ◆ Always position the fingers of all Featherboards in a stack so they are pointing in the same direction as you plan to feed the workpiece.

### NOTE

Never position the featherboard(s) closer to the cutter than  $\frac{1}{2}$ ". This distance between cutter and Featherboard, will assure that the fingers do not spring into the rotating cutter when the wood slides out from under the Featherboard."

### **WARNING**

- ◆ Do not use more than four Featherboards in a single stack. Stacking more than four featherboards could create an unstable as-

sembly. This oversize stack could be pulled from the miter slot, creating a dangerous situation.

- ◆ Set the holding force of the Featherboards so that they hold the workpiece firmly against the fence without so much force, that the workpiece is difficult to move past the Featherboards. This Featherboard stack is NOT intended to flatten or straighten warped boards.

## ASSEMBLY

These Stacking Featherboards can be configured in several ways:

### A Quad-Stack

To support work from 4-3/8 to 6" tall and more.

### Two Double-Stacks

To support work from 1-1/8" to 2-3/4" tall

### A Triple-Stack and single Featherboard

To support work from 2-3/4" to 4-3/8"

All configurations assemble in the same manner. Follow the instructions below for whichever set of Featherboards you plan to use. Refer to the assembly drawing for part positions, terminology and assembly order.

1. Slip two pins through a Bar. Insert each Pin from the bottom of the Bar to the top. Be sure the tabs under the head of the Pin are aligned in the slot of the Bar.

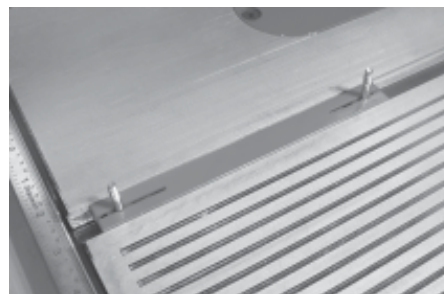

Figure 1

2. Place the Bar in the miter slot of your Worktable. Position the bar with the Pins up and the bar flush with the top of the Worktable as shown in Figure 1.
3. Set the Featherboard over the two pins. Be sure that the fingers of the Featherboard are pointing in the same direction as you will feed the wood past the cutter. Refer to the feed direction arrows on the Featherboard, see Figure 2.

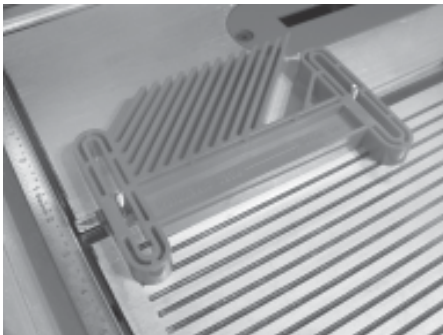

Figure 2

4. Thread a #10-24 Hex Nut on each Pin. Place this Nut on the Threaded end of the Pin. Tighten the Nut ONLY until it touches the top surface of the Featherboard. There should be 2-3 threads from the Pin above the nut, as shown in Figure 3. If the threads are not above the nut, check that the Pin tabs are aligned with the slot in the Bar.

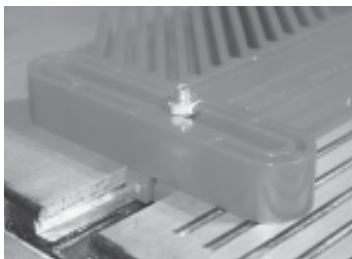
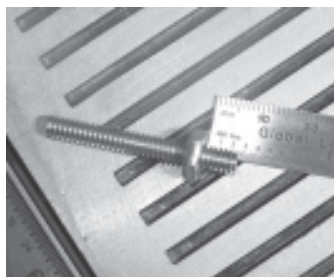

Figure 3

Figure 4



5. Thread one nut on one Stud. Position this nut so that there is precisely  $\frac{1}{4}$ " of thread protruding beyond the Nut, as shown in Figure 4. Repeat for the other studs.
6. Thread the Stud with Nut into a Coupling Nut. Thread the short end of the stud into the coupling nut until the Nut contacts the end of the Coupling Nut. Tighten the Nut against the end of the Coupling Nut with two wrenches, see Figure 5. Repeat this for the other Stud, Nut, and Coupling Nut combinations.

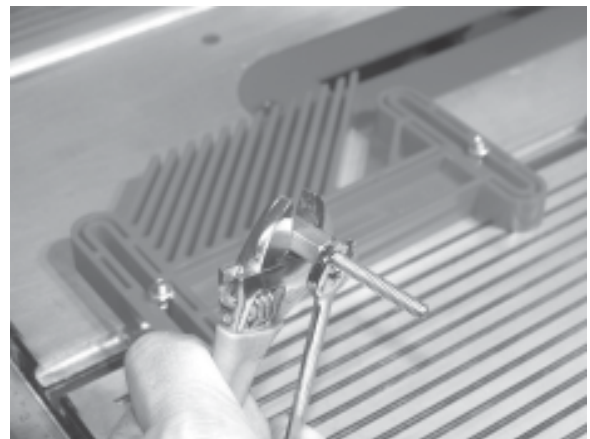

Figure 5

7. Thread a Coupling Nut-Stud assembly on the Pin. Place the coupling Nut on the Pin and thread it on the Pin until it is finger tight against the Hex Nut, as shown in Figure 6. Repeat this for the other Pin.



Figure 6

8. Lock the Stud assembly against the nut on the Pin. Use the Adjustable wrench to hold the Coupling Nut stationary while tightening the Hex Nut with the 3/8" Wrench, as shown in Figure 7. Repeat this on the second pin.



Figure 7

### **NOTE**

**Be sure to tighten the hex nut upward against the Coupling Nut without turning the Coupling Nut. Tightening the nut against the Coupling Nut will add just enough clearance to allow the hardware to slide in the Featherboard slot. If you turn the Coupling nut on the Stud, you will expand the bar, making the entire Featherboard assembly difficult to install and remove from the Table. When tightened properly, the Featherboard must slide easily under this Stud assembly.**

9. Place a 1" Tall Plastic Spacer over each stud assembly. Now place a plastic spacer over both stud and nut assemblies, see Figure 8.

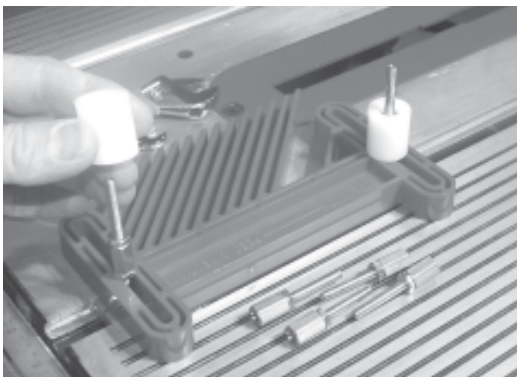

Figure 8

10. Install the second Featherboard. Place the next Featherboard over the stud assembly, on top of the Spacer, see Figure 9. Slide the Featherboard on the spacer until it sits balanced on the Spacers.

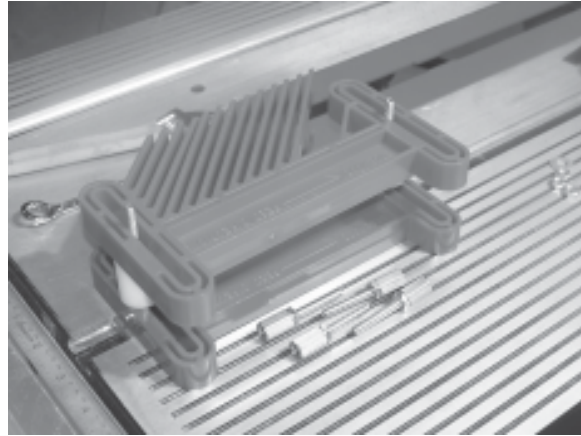

Figure 9

11. Repeat steps 6, 7, 8, 9 and 10 until the desired number of Featherboards are in the stack.
12. Install the Washer and Knob. With the last Featherboard in place, slip the Washer over the top end of the Stud. Measure the distance the Stud protrudes through the Washer. If it sticks out more than 5/16", the stud will have to be adjusted deeper in the coupling nut. Otherwise the Stud will thread too deep in the Knob and bottom out. Then the Knob will not tighten sufficiently to lock the Featherboard stack in the miter gauge slot. Thread the Knob on the stud. Repeat for second Washer and Knob.

## OPERATIONS

In order to use the Triple-Stack or Quad-Stack of Featherboards you must make one of the Vertical Fence Extensions shown the Table Saw and Bandsaw chapters in the Power Tool Woodworking for Everyone textbook. If you are using two Double-Stacks or two single Featherboards, the fences are tall enough to support the wood without using a Vertical Fence Extension.

Below are photos showing proper set up on different machines. Each photo shows proper use of the Featherboard Stack and the Vertical Fence Extension. Even though the photos are shown on a Mark-V, Model 520 or the Mark-7 Table Saw set up, the techniques are very similar for other Shopsmith multipurpose machines. For more information read, understand and follow your Table Saw and Bandsaw Owners Manuals. Also review the Table Saw and Bandsaw chapters in the Power Tool Woodworking for Everyone textbook that came with your machine.

### *Bandsaw Operations*

The photos below show typical Bandsaw, resaw operations on two different Shopsmith Bandsaws.

### **WARNING**

- ◆ **Read, follow and understand the instructions in your Bandsaw Owners Manual and the Power Tool Woodworking for Everyone text before using the Stacking Featherboards with the Bandsaw.**

#### Bandsaw (Cast Iron Table)

- Re-sawing using the Miter Gauge as a Resaw Guide with the home made Vertical Fence Extension. In order to mount the Featherboard Stack to the cast iron table, the Expansion Bar must be cut.

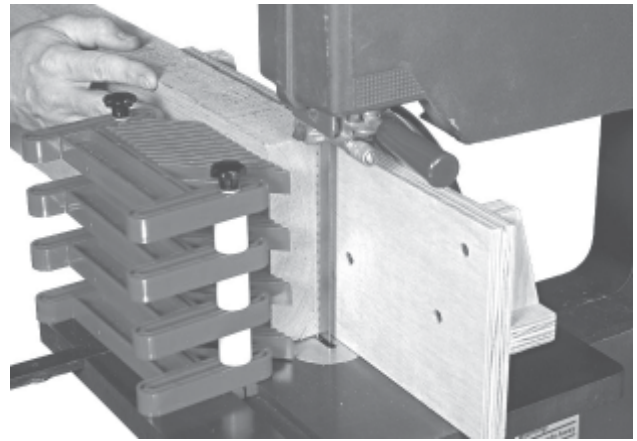

**Bandsaw (Cast Iron Table)**

1. Cut the Expansion Bar in three pieces using the "X" on the bottom as reference.
2. Use a handsaw to cut through the Expansion Bar at the intersection of the "X", as shown in Figure 10.

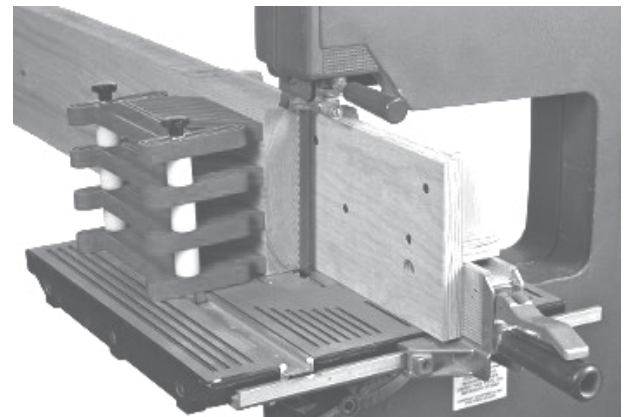

**Figure 10**

3. Discard the center section of the Expansion Bar.
4. Install the two ends of the Expansion Bar to the Featherboards as if it was uncut. This gap in the bar will now straddle the crossbar of the Miter Gauge.

#### Bandsaw (Aluminum Table)

- Re-sawing using the Bandsaw Fence as a Resaw Guide with the home made Vertical Fence Extension.



**Bandsaw (Aluminum Table)**

## *Table Saw Operations*

The photos below show some of the table saw operations where the Stacking Featherboards can be useful.

### **WARNING**

- ◆ **Read, follow and understand the instructions in your Mark-V or Mark-7 Owners Manual and the Power Tool Woodworking for Everyone text before using the Stacking Featherboards with the Table Saw.**

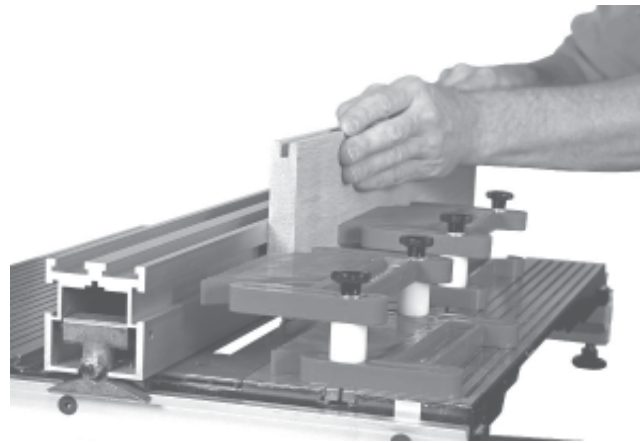

Cutting a Tongue or Groove with a Circular Saw Blade or dado head. Shown on a Model 520 Table Saw.

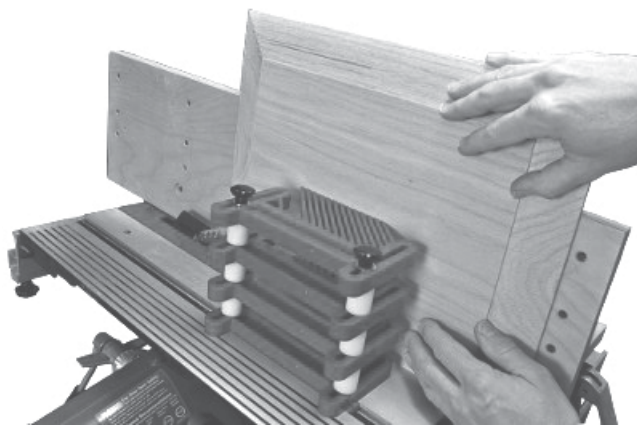

Cutting a raised Panel. Shown on a Model 520 Table Saw with the home made Vertical Fence Extension.



**Anytime there is a scrap piece of stock being cut away from a workpiece, the lower Featherboard in the outfeed stack must be offset. This positions it away from the stock, to avoid pinching the scrap against the stock and causing a kickback.**

## NOTE

**If you have further questions or need additional assistance, please contact Customer Service Toll Free 800/762-7555. Or visit our website: [www.shopsmith.com](http://www.shopsmith.com)**

